



PAL RSI and PAL RTC Sample Prep and Injection





PAL System's new generation of sample preparation and handling instruments.



Content

Introduction	4 - 7
Features & Benefits of the PAL RTC and RSI	8 - 9
PAL RTC	10 - 11
PAL RSI	12 - 13
PAL DHR Dual Head	14 - 15
Tools and Modules	16 - 23
PAL Sample Control	24 - 25
PAL Method Composer	26 - 27
Applications	28 - 31
PAL Accessories & Consumables	32 - 33
Specifications	34 - 35



The PAL System is one of the most widely used and successful sample preparation and handling platforms.

The PAL System is one of the most widely used and successful sample preparation and handling platforms.

PAL System is your tool box for sample preparation, from a simple liquid injection to complete workflows. A PAL System can be adapted or extended to meet almost any requirement.

Numerous options allow to increase sample capacity or add further modules for sample preparation. Listed below are the method steps that a PAL System can perform:

- Liquid injection GC and LC
- Gas injection
- Liquid addition
- Headspace sampling
- Dynamic headspace sampling
- SPME and SPME Arrow sampling
- Incubation 35-200°C
- Tool change (PAL RTC only)
- Transport of vials and other objects
- Vortex mixing
- Dilution
- Standard addition
- Liquid / liquid extraction (LLE)
- Derivatizations
- Solid phase extraction (SPE)

More than 50'000 users in gas and liquid chromatography, mass spectrometry and optical spectroscopy can't be wrong. Read about their success stories in "[Ingenious News](#)" where you get regular application updates from users.



Sample preparation is the key to success to achieve precise and accurate results.

For a typical chromatographical analysis 61 % of time is spent on sample prep, 30 % of errors are linked to sample prep*.



Time Spent on Typical Chromatographic Analysis

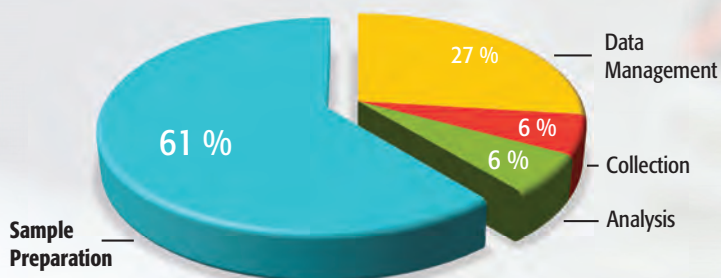

Sources of Error Generated During Chromatographic Analysis

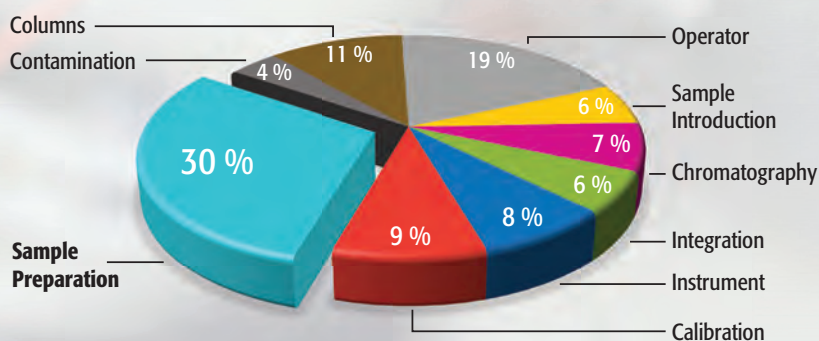

* data taken from the book "SAMPLE PREPARATION FUNDAMENTALS FOR CHROMATOGRAPHY" from Agilent Technologies.



PAL RTC - Highest Productivity & Flexibility

The PAL RTC with Robotic Tool Change is the logical (r)evolution of the successful PAL-xt product line. It is a robotic platform for the efficient and safe automation of most sample preparation steps.

The robotic change of tools enables unattended 24/7 operation, even for multistep workflows and thereby greatly increases the productivity of labs. At the same time process safety is optimized since all operations become traceable.

PAL RSI - The Workhorse

The RSI is the robust workhorse for analytical labs. It is the cost effective solution for labs in need of robustness and uncompromising performance.

The PAL RSI is a safe investment: if your requirements grow an upgrade to the full RTC functionality is possible and gives access to complete workflow automation.

PAL Sample Control Software for Efficient Operation of PAL RTC & RSI

The latest generation of PALs can all be controlled by the user friendly PAL Sample Control software. It interfaces seamlessly with many common CDS and MS-data systems (e.g. Agilent Chemstation, Masshunter, Sciex Analyst, or Thermo Scientific Xcalibur) or can be used for offline sample preparation. With a few clicks you can import or generate sample lists and start the data acquisition. Or you can quickly set up workflows to eliminate tedious manual operations. PAL Sample Control allows overlapping of time consuming steps. This increases sample throughput greatly and boosts productivity.

PAL Method Composer

If a PAL System is already integrated in a GC-MS or LC-MS system, PAL Method Composer lets you easily create and test sample prep methods for running it.

The graphical user interface allows the creation of a method by drag & drop. The check for validity of the method is performed automatically on the fly.

Innovative Features saving time...

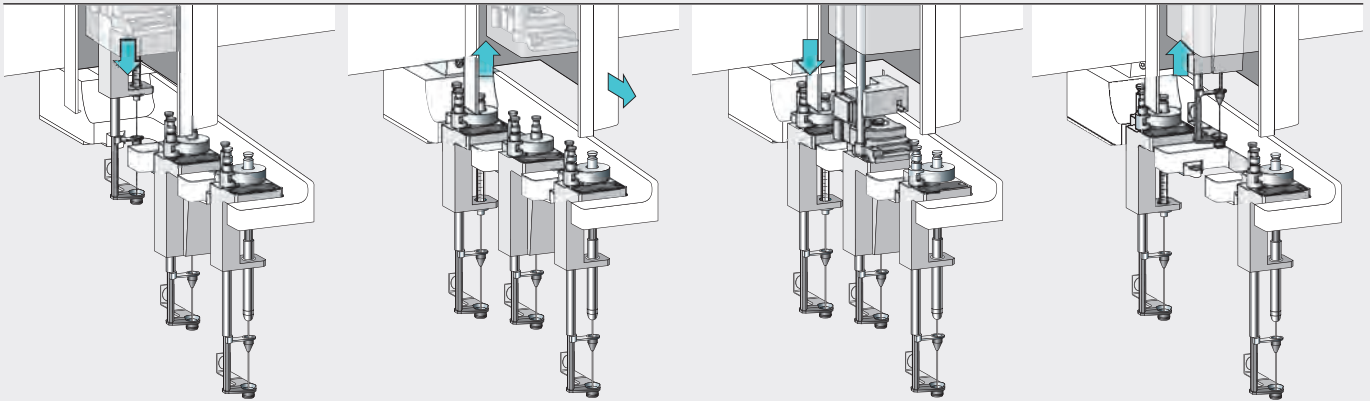

Robotic Tool Change (PAL RTC only) for productivity

The unique Park Station enables the Robotic Tool Change.

- With different syringes available always the ideal one can be selected, for instance one syringe is reserved for standard addition to minimize carryover while 2 others are used for dilution steps.
- The RTC speeds up SPME method development by allowing automatic sampling of different types of SPME fibers.
- The PAL RTC identifies type of tool and its position automatically.

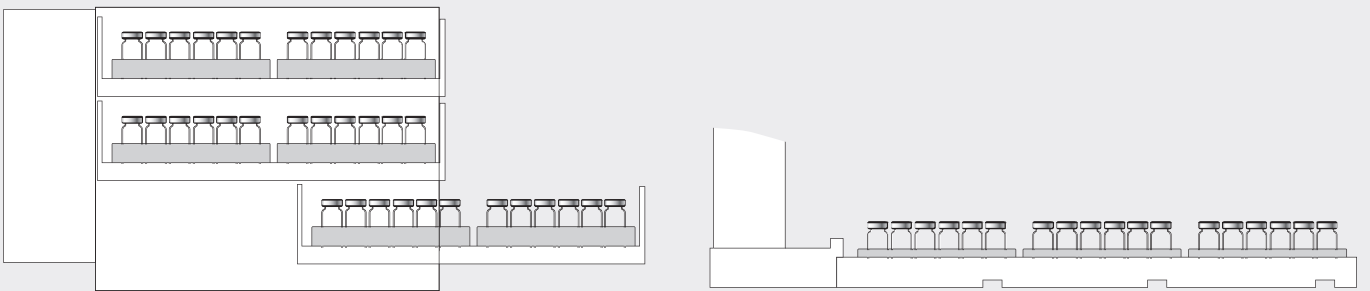

Increased Vial Capacity

- 162 x 2mL or 60 x 10mL or 20mL vials/tray holder, other vial types and microtiter plates can be handled.
- With temperature controlled stacks a maximum of 9216 samples out of 24 MTPs can be handled.
- Cooled Stack with position control.

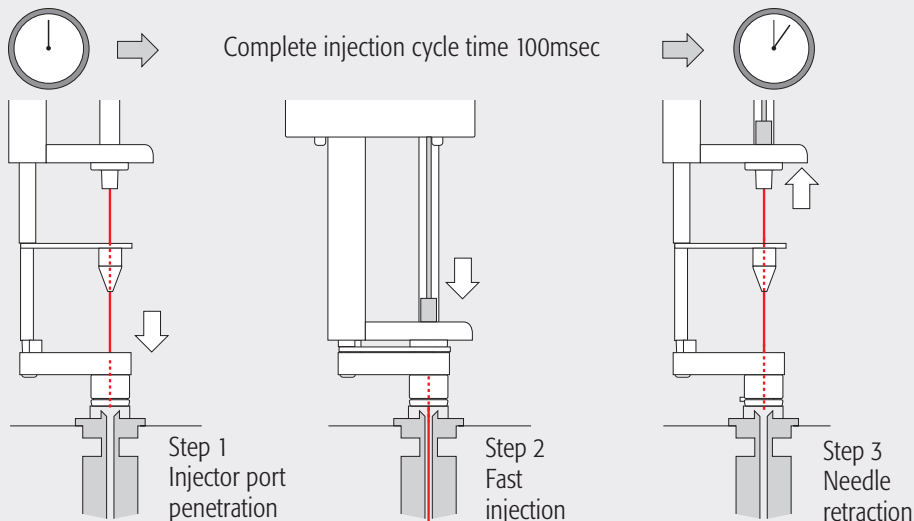

Discrimination free Injection

Ultrafast injections down to 100 ms reduce discrimination in GC down to $C_{40}/C_{20} > 0.98$.

...and avoiding mistakes.

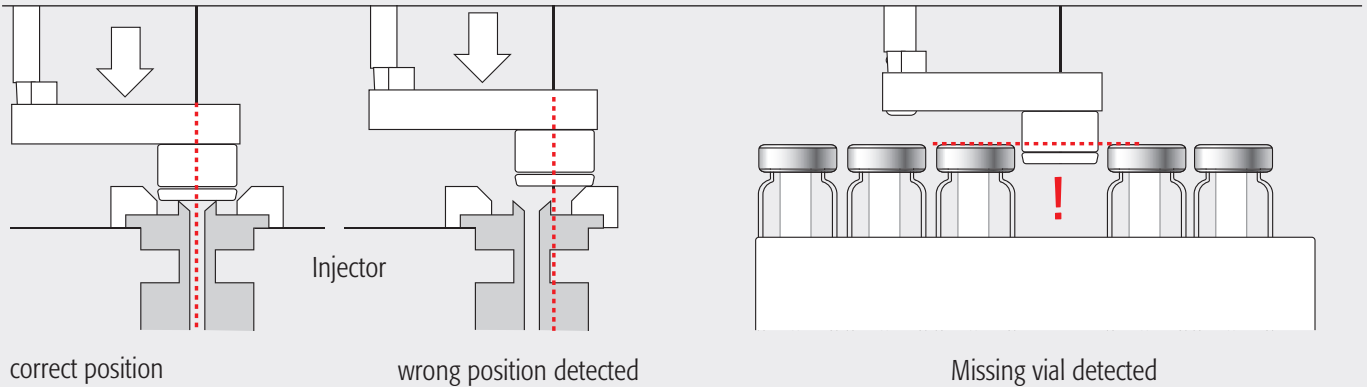

Process safety

Position detection means process safety. Missing vials or the correct position of the injector are detected and traced. Position detection for the temperature controlled stack ensures that the drawer is in the correct position (open / closed) and the temperature is monitored.

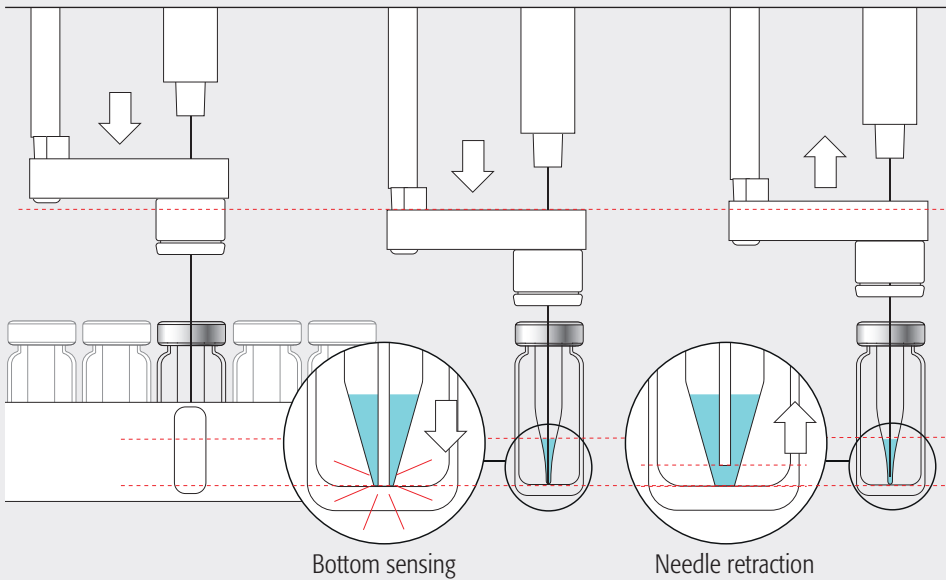

Minimized carryover and reproducible injection of minute sample volumes

Bottom sensing makes sure that small volumes can be injected out of a few μL of sample (e.g. 3 x 1 μL out of 5 μL).

With Constant Force Technology the PAL detects the correct position of the needle in the specially designed needle seal. Potential carryover is avoided.

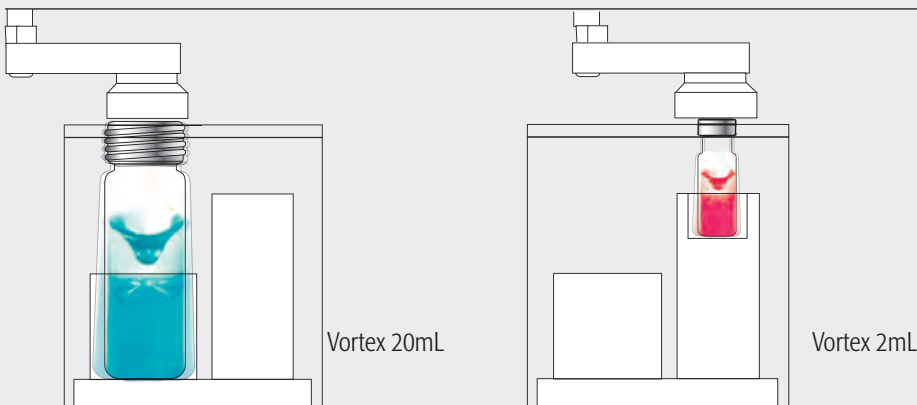
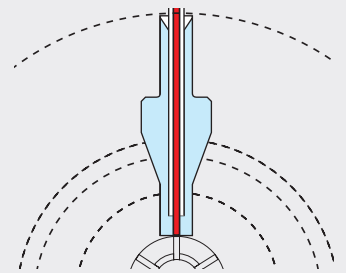

Efficient Mixing

The vortex mixer is indispensable for serial dilutions or extraction steps. Supported vial sizes are 2, 10 and 20mL.

The PAL RTC is all about increasing productivity.

Robotic Tool Change takes productivity to a new level.

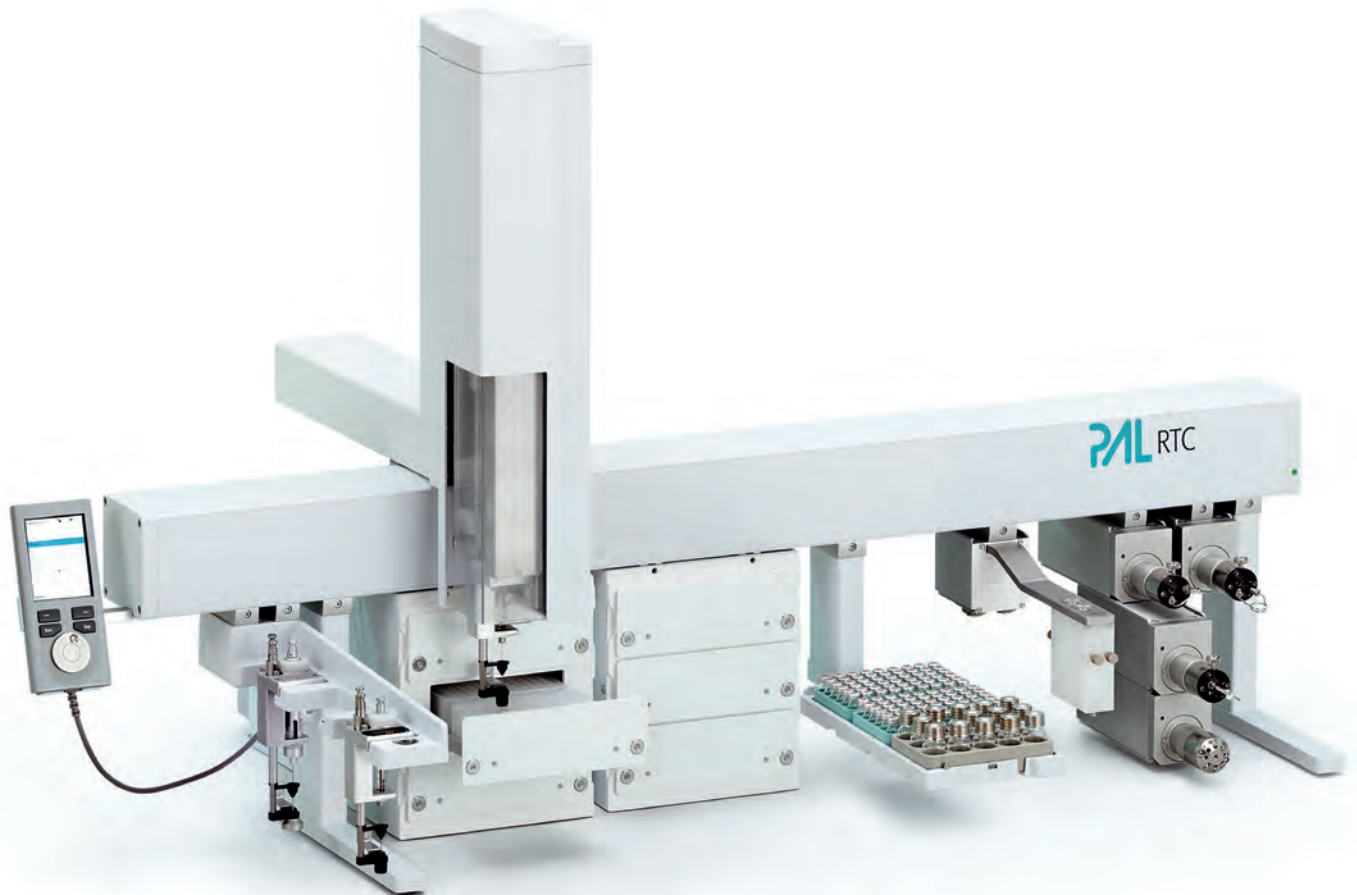

PAL RTC with extended x-axis for LC/MS

Automation improves process safety

Automation is the way to increase productivity and (process) safety in the laboratory. Transferring repetitive or dangerous manual tasks to a robot improves safety. The possibility to run the instrument 24h/day increases throughput, especially for long sample preparations.

The PAL RTC was developed to maximize productivity in analytical and clinical labs. Robotic Tool Change (RTC) brings sample preparation to a higher level.

Every process requires a number of different tools for best performance, e.g. a 10 μL syringe for the accurate addition of small volumes followed by the dilution with a 1mL syringe. Robotic Tool Change allows to switch between different tools automatically.

This additional versatility in combination with the large number of available tools enable the design of tailored automation processes.



Park Station for Robotic Tool Change

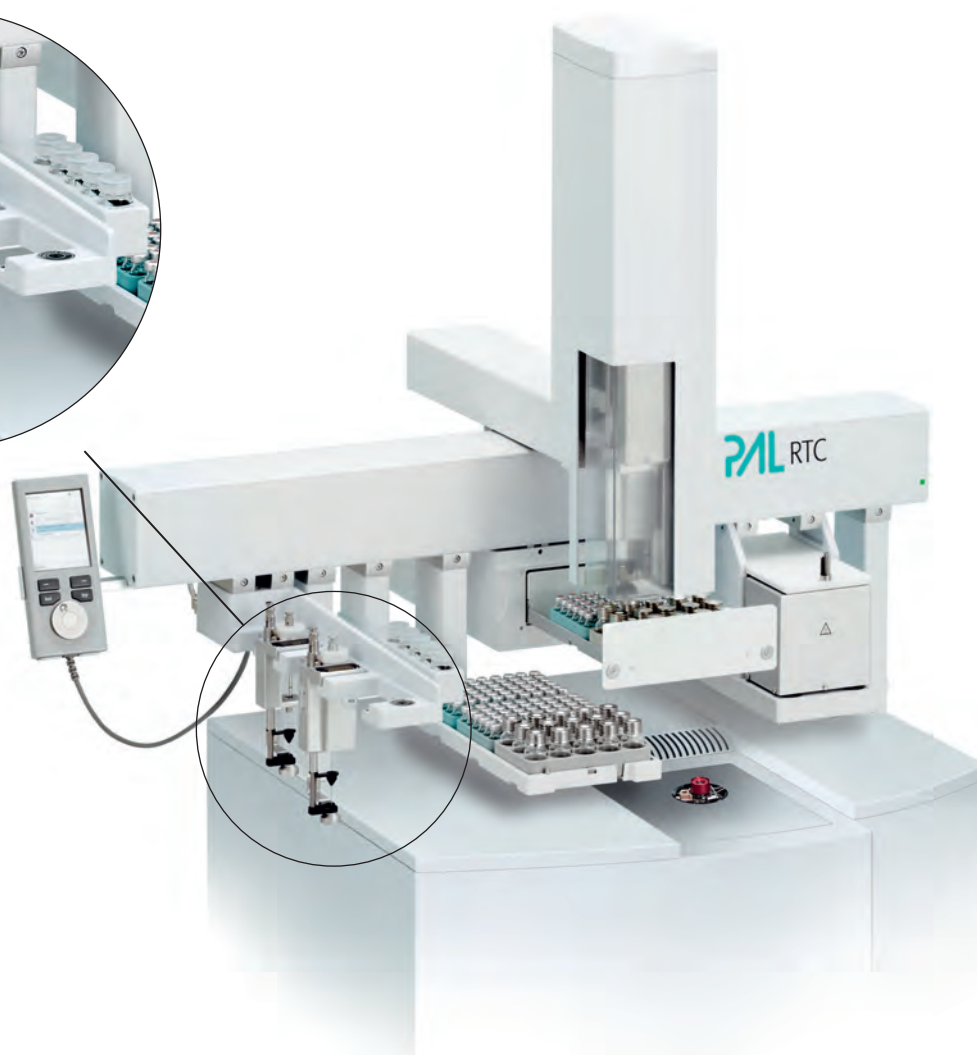

PAL RTC with standard x-axis for GC & GC/MS

Ingeniously productive.

- Automatic selection of the syringe with optimal accuracy for adding standards or preparing serial dilutions
- On the fly switching between a syringe tool for the addition of an internal standard and the LC/MS Tool for subsequent analysis
- Possibility to permanently configure several workflows on one system for a walk-up prep station, e.g. Liquid/Liquid Extraction and Solid Phase Extraction (SPE)
- Automated optimization of methods e.g. by selecting the most suitable Solid Phase Micro Extraction (SPME) fiber from an array of 4 different ones
- Derivatization reactions performed without manual intervention for productivity, protection against hazardous chemicals and process safety
- Automation of labor intensive manual workflows like protein digestion

For detailed examples of workflows see p.28 - 31.

The PAL RSI is the reliable workhorse for analytical labs.

The PAL RSI defines the industry standard for intelligent sample preparation.

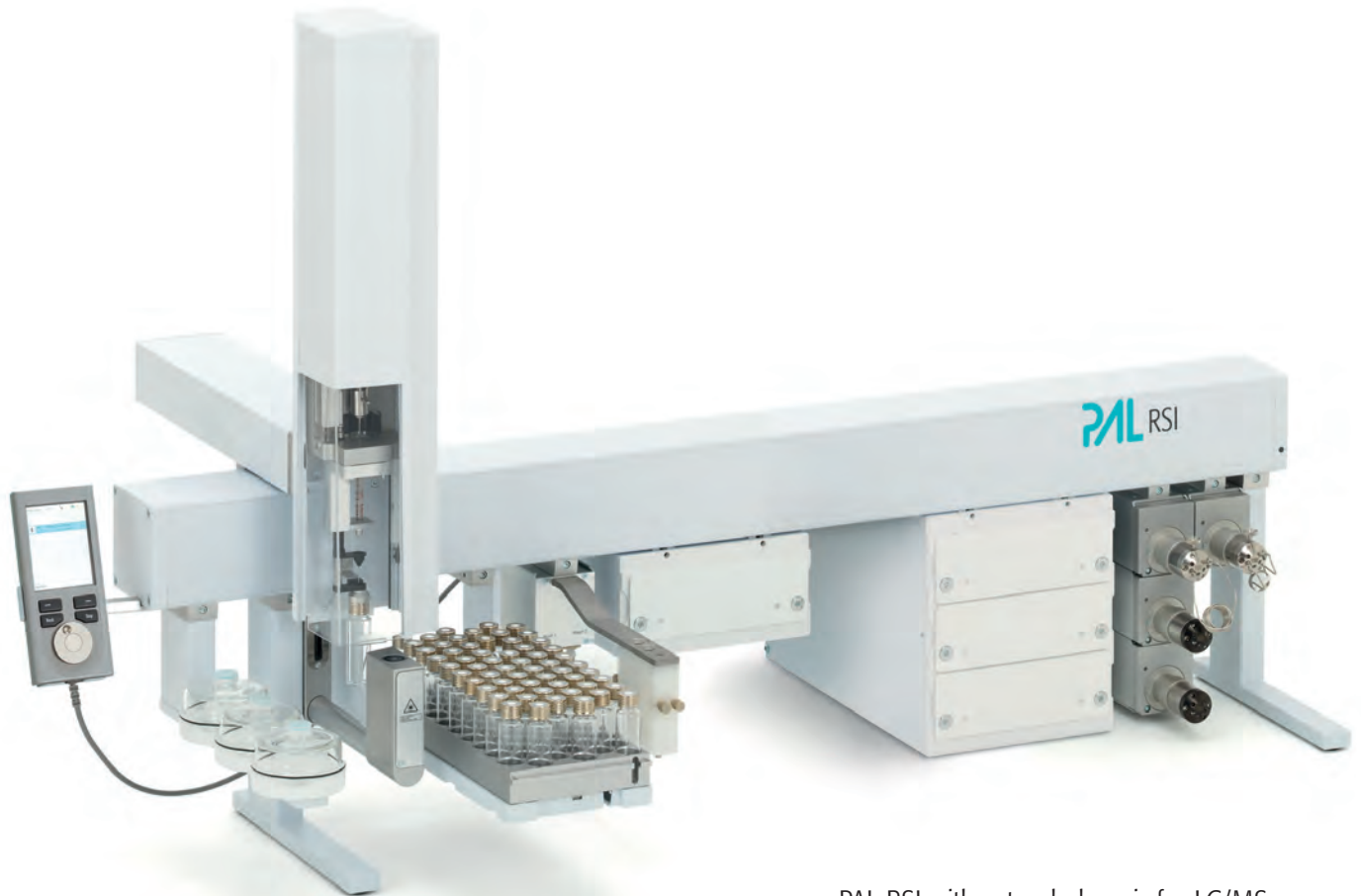

PAL RSI with extended x-axis for LC/MS

Ingeniously reliable.

Laboratories work under time pressure and often with a tremendous workload. The reliability of hardware and software should not be something the user has to worry about. Reliability is just expected from every tool.

That is exactly what the PAL RSI was designed for. It is a tool that you can rely on. 50.000 PAL systems worldwide are proof of this.





PAL RSI with standard x-axis for GC & GC/MS

The most flexible system on the market.

RSI is a flexible tool. Its open and modular architecture makes it the most versatile system on the market. Tools can be exchanged readily within minutes.

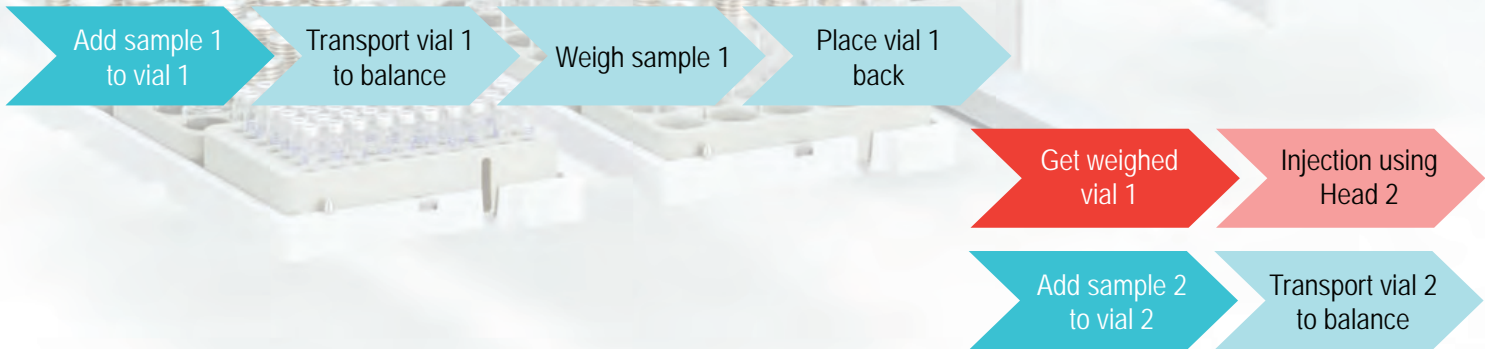
PAL customers working with GC love the possibility to use liquid, headspace or SPME sampling on the same system. LC customers use the PAL because of its huge sample capacity, the range of syringes and valves available.



-  Workflow 1 (Head 1)
-  Workflow 2 (Head 2)

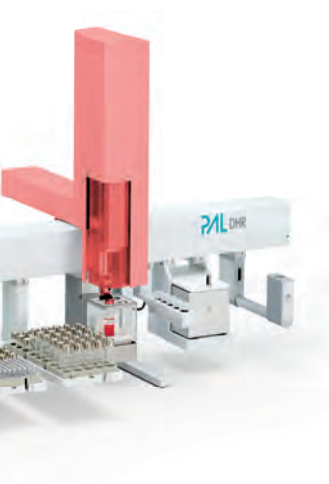

PAL DHR DUAL HEAD

Productivity x2

- Two heads can move independently
- The heads can execute two independent workflows
 - Headspace sampling with standard addition
 - Parallel injections into two GC- or LC-systems
- The software optimizes the time table to maximize productivity
- Collision control → process safety and easy programming
- 120 or 160 cm wide working area
- Combinations of RTC/RSI heads
- With an RTC head toolchange expands the options further

Application Examples

- Automated weighing of samples, combined with the analysis of a weighed sample
- High throughput LCMS injections with 2 completely independent LC streams (2 injection valves, 2 columns or staggered injections into multiple streams.)
- Sample prep combined with parallel headspace GC analysis

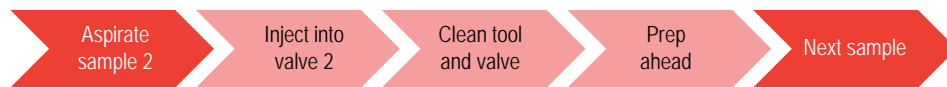
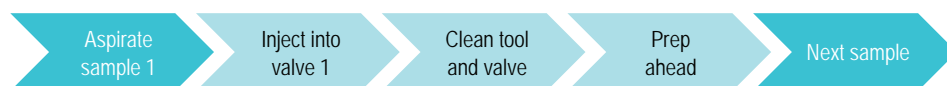

■ Workflow 1 (Head 1)

■ Workflow 2 (Head 2)

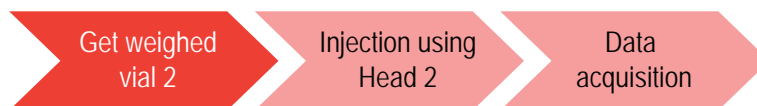
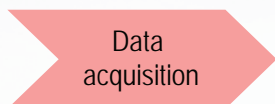



For good sample preparation you need the right tools and modules. Here is the complete toolbox.

The right tool for each application

Starting from 10 mL of a water sample, extracting pesticides by SPE and precisely injecting 1 μ L of extract: the PAL Sytem performs this job flawlessly. This is only one example how PAL System improves productivity and process safety.

Liquid, gaseous or solid samples require different workflows and therefore different tools. The following pages introduce you to the PAL Toolbox equipped with the best tools and modules available for sample preparation.

Change the tool at any time with the Park Station (PAL RTC only)

The unique Park Station allows a robotic tool change (syringes with different volumes or different tool types) for advanced sample preparation, liquid handling (dilutions), derivatization steps or any other time consuming repetitive step. The additional versatility in combination with the increased volume range are significant benefits and allow the realization of tailor-made automation processes.

- Park Station for up to three injection tools
- Installation of up to 2 Park Stations on one PAL RTC
- Process safety through tool recognition and position control
- Designed for automated screening of method conditions with multiple tools



PAL Tools

Liquid Syringe Tool

- Dedicated Tools for 57 mm or 85 mm syringe needle lengths available
- Syringes available:
 - 1.2µL / 5µL / 10µL / 100µL with D7 tool
 - 250µL / 500µL / 1'000µL with D8 tool
 - 5'000µL / 10'000µL with D18 tool



85 mm
needle length



57 mm
needle length

Headspace Tool

- Dedicated tools for different syringe types available:
 - 1 mL / 2.5 mL / 5 mL (with corresponding tools)
- Syringe temperature 40°C up to 150°C in 1°C steps
- Syringe flush with inert gas flow through X-Y-Z rail
- Magnetic vial transport for 2 mL, 10 mL and 20 mL vials



SPME Fiber Tool

- New SPME holder for increased fiber protection
- Compatible with a variety of SPME fibers
- Easy fiber exchange by hand
- For 10 mm or 20 mm fiber length
- SPME Fibers are available with the following sorbents:
 - PDMS, DVB, PA, Carbon WR, PDMS/Carbon WR, PDMS/Carbon WR/DVB



SPME Arrow Tool

- For SPME Arrow fibers with 1.1 and 1.5 mm diameter
- Easy fiber exchange by hand
- SPME Arrows are available with the following sorbents:
 - PDMS, DVB, PA, Carbon WR, PDMS/Carbon WR, PDMS/Carbon WR/DVB



ITEX DHS Tool

- For powerful dynamic headspace extractions with Tenax TA trap, other materials available
- Active cooling to minimize idle times
- Temperature range: 40 - 350°C for efficient desorption



LCMS Tool

- The special design minimizes carryover even for the most sensitive detectors
- Enables special injection techniques like sandwiching a sample between air gaps for accurate small volume injections
- Flow control guarantees bubble-free solvent delivery
- Position detection for zero dead volume positioning of syringe needle in the injector port



Pipette Tool

- For automated pipetting with 200 µL or 1000 µL tips
- Single or multi-dispense mode
- A special adapter allows direct injection into LC-valves
- Also works with capped vials in combination with the DeCapper Module



Dilutor Tool

- For the addition of larger amounts of liquids
- With the special "transfer" mode also small volumes of liquids can be handled with high precision



PAL Modules

Agitator Module

- For the incubation and agitation of samples.
- 6 positions for 20mL vials
- Temperature range 40-200°C
- Agitation speed 250-750rpm
- Optional adapters for 2mL or 10mL vials



Barcode Reader Module

This unique Barcode Reader allows PAL RSI and PAL RTC to read the barcode labels on 2mL, 10mL and 20mL vials regardless of the orientation on the vials. Therefore it ensures highest process safety and traceability.

- Reads horizontal 1D barcodes
- Two scanners allow identification of vials irrespective of position of the barcode
- Works with 2mL / 10mL / 20mL vials



DeCapper Module

- Opens/closes 2, 10, 20 mL screw cap vials without any change of hardware (no adapters required)
- Defined torque guarantees the reproducible and leak-tight closing of headspace vials



Dilutor Module & Tool

- For the efficient and accurate addition of larger amounts of liquids
- 100µL, 1mL, 5mL & 10mL dispensing syringes available
- Optional selector valves allow dispensing of up to 5 different liquids



Fast Wash Module

- Cleans syringes of gauges 19 to 26
- Integrated pumps for active wash solvent delivery
- Supports two different wash solvents (aqueous and organic)
- Reduces wash solvent consumption by automatic flow adjustments
- Can be mounted underneath Valve Drives to minimize required space



Heatex Stirrer Module

- For powerful mixing and heating in sample prep and SPME Arrow
- Temperature range 30° - 150°C
- Stirring speed up to 1600 rpm (i.e. 200 cycloidal loops)
- Optimized for 20mL vials (for 10 mL vials special adapters are required)



Large Wash Module

- Wash Module for large volume injections:
- 2 x 100mL solvent container (glass) with septum cap
- Waste port with tubing olive to connect waste bottle



Peltier Stack Modules (2DW, 6DW and 12MT)

For the storage of two (2DW) or 6 (6DW) racks or plates or 12MT plates (12 MT) under defined temperature conditions between 4°C and 40°C. Allows to use transparent standard vials with light sensitive compounds.

Capacity 2DW:

- 2x MTP (Multi Titer Plate)
- or 2x DW (Deep Well Plate)
- or 2x VT15 (15 x 10mL)
- or 2x VT 54 (54 x 2mL)
- or 2x VT70 (70 x 1mL)
- or combinations

Capacity 6DW:

- 6x MTP (Multi Titer Plate)
- or 6x DW (Deep Well Plate)
- or 6x VT15 (15 x 10mL)
- or 6x VT 54 (54 x 2mL)
- or 6x VT70 (70 x 1mL)
- or combinations

Capacity 12MT:

- 12x MTP (Multi Titer Plate, shallow well)



(Peltier Stack 6DW shown)

Solvent Module

- For large solvent demands, e.g. for the addition of larger volumes of solvents or serial dilutions:
- 3 x 100mL solvent container (glass) with septum cap



SPME Arrow Conditioning Module

- For the conditioning of SPME Arrow and SPME fibers prior to sample enrichment, max. 350°C
- Position for automated conditioning
- Position for manual pre-conditioning
- Automated purge gas valve
- Manual gas valve for pre-conditioning



SPME Fiber Conditioning Module

- For the conditioning of SPME fibers prior to sample collection
- Temperature range up to 350°C
- Purge gas connection for more efficiency
- Additional port for a replacement fiber

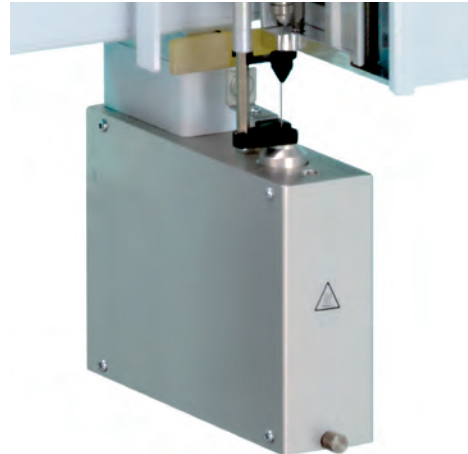

Stack Modules (6 DW and 12 MT)

For the storage of racks or plates at room temperature. Allows to store samples with light sensitive compounds. A maximum of four Stacks can be configured on a PAL with extended x-axis length.

Capacity 6 DW:

- 6x MTP (Multi Titer Plate)
- or 6x DW (Deep Well Plate)
- or 6x VT15 (15 x 10mL)
- or 6x VT54 (54 x 2mL)
- or 6x VT70 (70 x 1mL)
- or combinations

Capacity 12 MT:

- 12x MTP (Multi Titer Plate, shallow well)



(Stack 6DW shown)

Standard Wash Module

- Wash Module for low volume injections
- 4x 10mL wash solvent vials
- 1x 10mL waste vial
- Optional Waste Port Adapter to connect a tube to a waste bottle



Valve Drive Module

Universal Valve Drive for applications like sample injection, column switching for online LC-LC/MS or online SPE-LC/MS, Multiplexing, column selection and many more.

- Valve Drive supports VICI/Valco and Rheodyne valve types
- Injection port bottom sensing minimizes carryover
- Constant Force Technology to reduce dead volume during injection process
- UHPLC/HPLC: up to 50% faster switching times for optimum system performance and prolonged column life time
- Stackable design to reduce the space required
- Huge flexibility to arrange multiple valve solutions
- The Fast Wash Module is also stackable below a Valve Drive



Two Injection Valves and two Selector Valves. Staggered injection configuration reduces space required.

Trayholder

The Trayholder offers sample storage at room temperature. A PAL with extended x-axis length can hold up to 7 Trayholders.

Capacity:

- 3x MTP (Multi Titer Plate)
- or 3x DW (Deep Well Plate)
- or 3x VT15 (15 x 10/20mL)
- or 3x VT54 (54 x 2mL)
- or 3x VT70 (70 x 1mL)
- or combinations
- or 60x 10/20mL (with one R60 tray)



Vortex Mixer Module

- For efficient mixing (dilution / extraction).
- Standard vial sizes: 2mL / 10mL / 20mL
- 1 additional slot for custom specific vials
- Provides efficient mixing with up to 2000rpm



For more information about PAL Tools and Modules please visit our website: www.palsystem.com



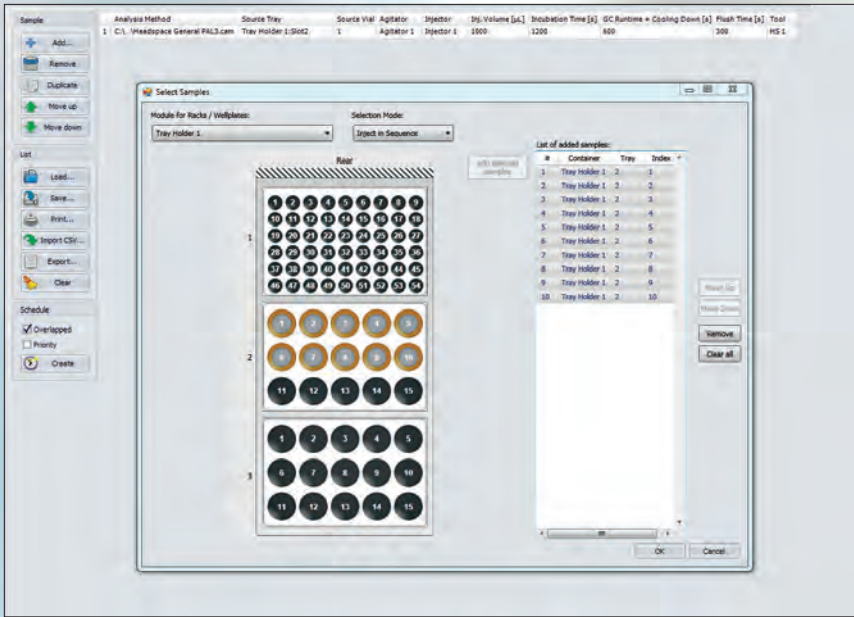

Easy to use

Creation or import of sample lists is done with a few clicks.

With one more click sample preparation and data acquisition are started.

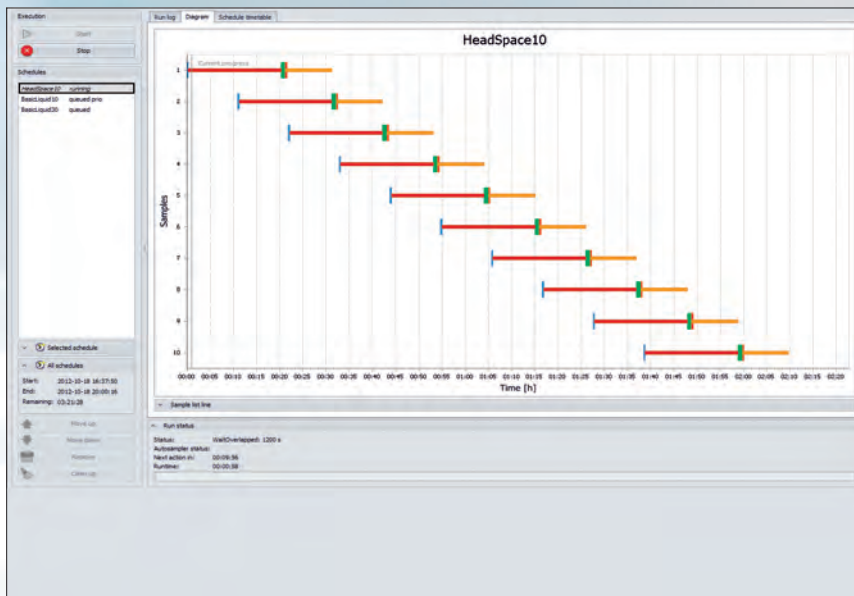

Productivity

PAL Sample Control optimizes productivity by overlapping individual steps. In many cases runtimes of sequences can be cut to 1/3 or less compared to a sequential procedure.

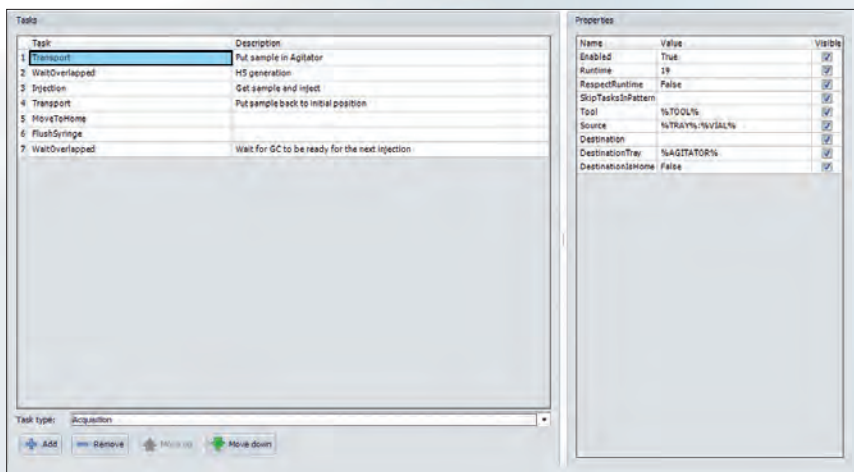

Powerful Method Editor

A powerful yet easy to use tool to generate custom methods is included.



PAL Sample Control

Easy to use routine software

PAL Sample Control software is the user-friendly tool for the daily routine jobs. With a few clicks sample lists are generated or imported. Now PAL Sample Control starts the operation and the data acquisition. Since PAL Sample Control interfaces seamlessly with most of the major chromatographic or MS data systems only one sample list has to be handled. Different user levels ensure process safety.

Productivity

PAL Sample Control allows overlapping of time consuming steps. It optimizes automatically the timing of various steps in a sample preparation process and generates a schedule that minimizes the runtimes of sequences. This increases sample throughput greatly and boosts productivity.

Powerful Method Editor

While PAL Sample Control is straightforward to use in the daily operations it is also a powerful tool for the generation of tailored methods. A set of tested methods that comes with every system (e.g. headspace injection, partial loop liquid injection) can be used as templates and optimized or tailored for specific workflows. Furthermore a large number of building blocks (tasks) for method development are part of the software. These building blocks make it easy to generate new methods, even for complex workflows. PAL Sample Control is required for operating the PAL DHR.

PAL Sample Control is shipped with every PAL System.

Supported CDS and MS-Data systems

- Analyst
- ChemStation LC/GC/MSD
- Chromcard
- ChromPerfect
- ChromQuest
- Clarity
- Empower 2
- EZChrom
- MassHunter for GC- MS, LC-MS
- MassLynx
- Master Lab
- MS Workstation
- QuanLab
- Xcalibur





PAL Method Composer, methods in minutes

PAL Method Composer is a tool to intuitively generate methods for the integration in Chromatographic Data Systems (CDS). By simply dragging and dropping of the individual prep steps you can build a method in minutes. Each step's functions and parameters are explained. The instrument configuration is visualized to easily optimize the sequence. PAL Method Composer gives users easy access to tailored methods.

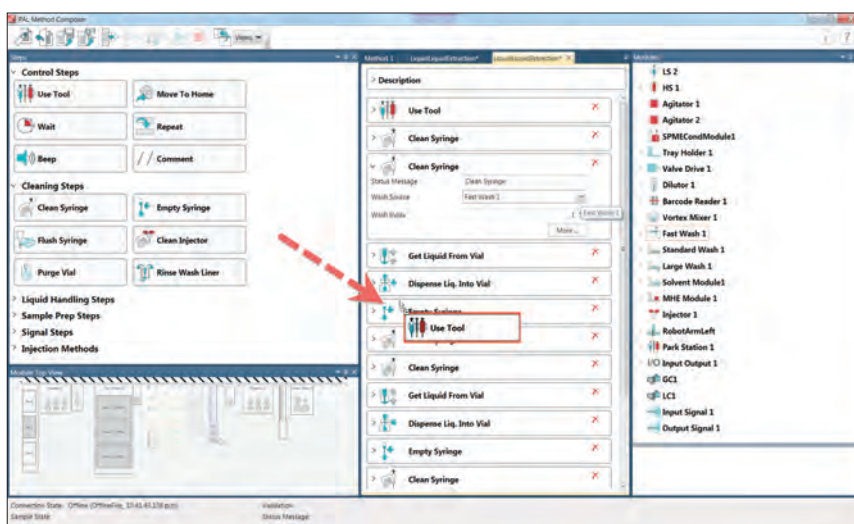

The parameters of the steps are default values that were experimentally determined. However, each step can be adjusted for specific methods.

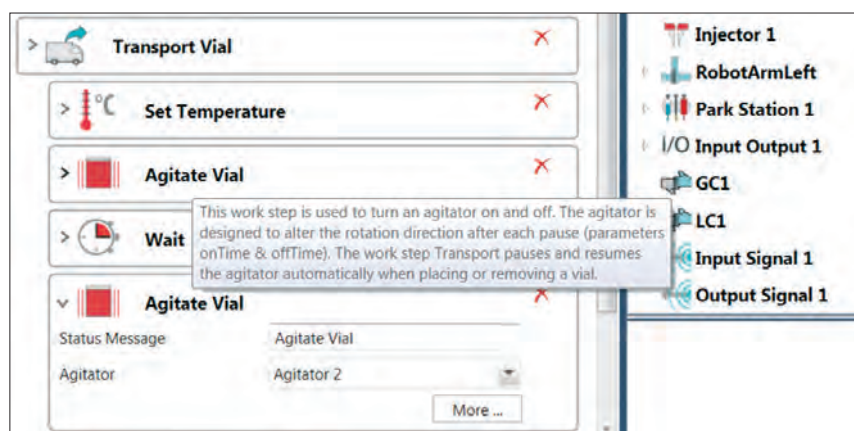

PAL Method Composer works with the following CDS:

- ChemStation / MassHunter
- GCMSsolution Software / LabSolutions
- Xcalibur

Automated sample prep is reliable, traceable, productive.

Processing of blood samples with protein precipitation, directly from primary tubes

- Aspirate 50 μ L whole blood from
- ▼ Dispense blood into 2 mL vial
- ▼ Clean tool
- ▼ Add 250 μ L water
- ▼ Add 750 μ L precipitation solvent
- ▼ Vortex 90 sec
- ▼ Centrifuge vial @ 3000 g for 300 sec
- ▼ Inject 5 μ L of supernatant
- ▼ Start LC-MS
- ▼ Clean tool

▶ Next sample

The workflows and application examples (following pages) were all realized with PAL Sample Control.

The tools and modules applied are shown.

Liquid-liquid extraction (LLE), often used, works best if automated

- Aspirate sample
- ▼ Dispense into 10 mL vial
- ▼ Clean tool
- ▼ Add 2 mL water
- ▼ Add 2 mL hexane
- ▼ Vortex 60 sec
- ▼ Inject 5 μ L of supernatant
- ▼ Clean tool

▶ Next sample

Automated analysis of fatty acid methyl esters (FAME)

Start Trans-esterification

Add ISTD

Add NaOMe

Vortex vial

Wait (Derivatization time)

Add heptane

Vortex vial

Add citrate

Vortex vial

Inject sample

Start analytical run

End derivatization

Start Trans-esterification of next sample

The trans-esterification of fatty acids to generate the corresponding methyl esters (FAME) is a very common and at the same time tedious procedure. Its automation increases productivity and prevents exposure of humans to hazardous chemicals.

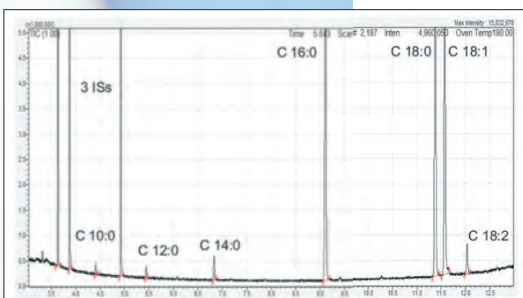

μ Solid Phase Extraction (SPE), the express way to clean samples

A wide variety of materials allows the selective clean-up of samples for further analysis.

Condition cartridge

Transfer sample to cartridge

Wash sample/cartridge

Remove wash solvent

Elute sample

Inject eluted sample

Start analytical run

Start SPE of next sample

You find all our application notes on:

<http://www.palssystem.com/index.php?id=813>



Contact the experts for sample prep:

The methods described here are available from selected VARs.

<http://www.palssystem.com/index.php?id=138>



Fully integrated automated Bligh and Dyer extraction and dual-column analysis for metabolomics analyses of tissues and cells.

Emmanuel Varesio, Sandra Jahn, Sandrine Cudré, Gérard Hopfgartner, Life Sciences Mass Spectrometry, School of Pharmaceutical Sciences, University of Geneva, University of Lausanne, Switzerland; Renzo Piconi, Guenter Boehm, Director Applications and Customer Communications, CTC Analytics AG, Zwingen, Switzerland

Conclusions

As laboratories are striving to uncover more «unknowns» and increase our understanding of biological processes there is a drive for procedures to become more efficient and repeatable. This is also true for extraction procedures which when performed manually can be time intensive and cumbersome, taking the valuable time of scientists. The automated Bligh and Dyer extraction described here was found to not only be more time efficient, but also to improve repeatability and quality of extraction and separation when compared to the standard manual approach.

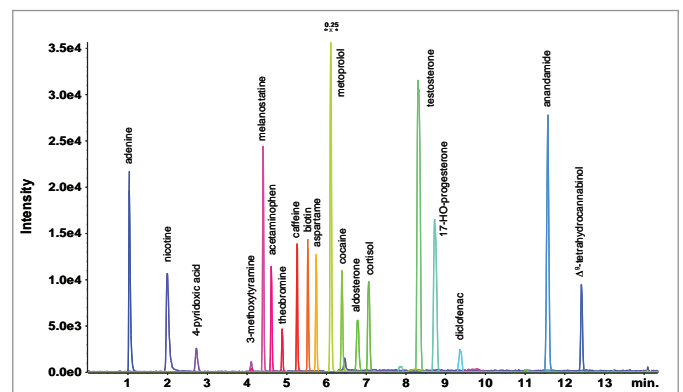
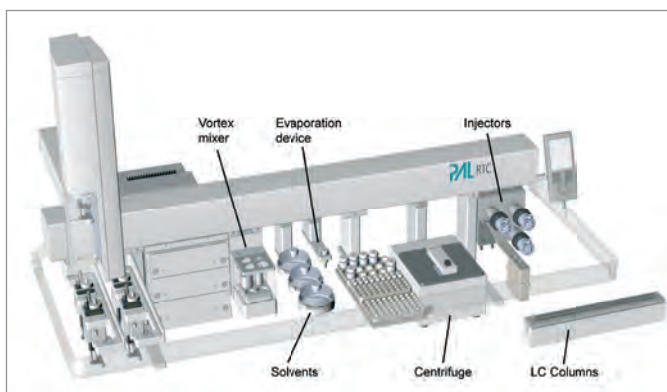
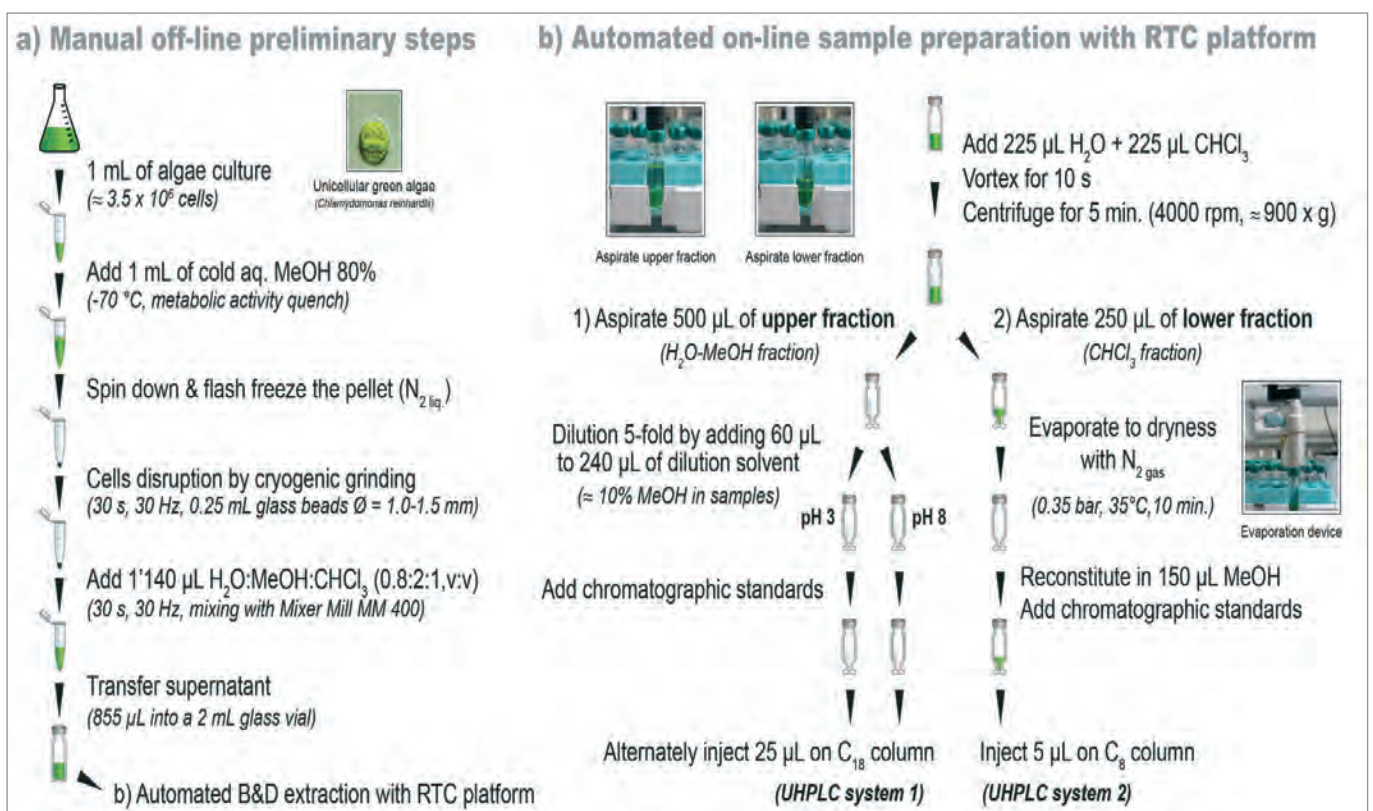

Real time monitoring for off-flavour compounds using a functionalized autosampler with SPME-GC-MS/MS.

Jaewon Choi, Sung-Yun Ahn, Yuns Kim, Ilhwan Choi, Water Analysis & Research Center, K-water
 Wonkyoung Lee*, Moondon Choi*, Jongsu Park*, * Euro Science, Seoul, South Korea

Conclusions

- This real time monitoring system has been operating continuously for several months. A temporary trend was observed for geosmin during 2 months.
- This system uses standard instrumentation, and is harmonized with the accredited method for drinking water of Korean Ministry of Environment (MOE) including adding internal standard and salt.

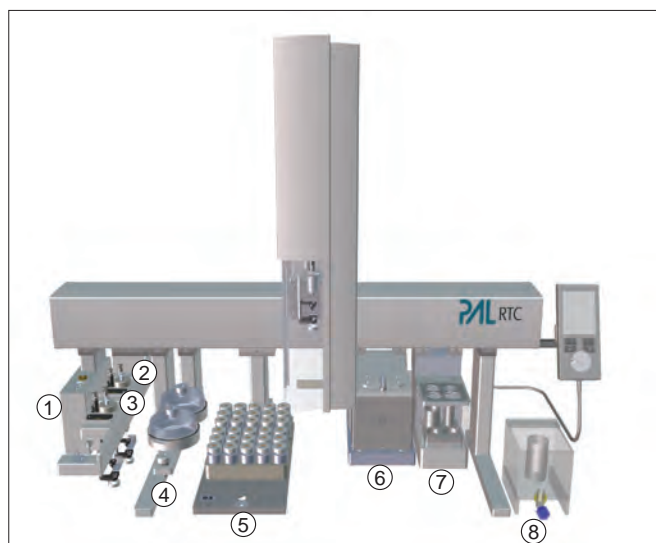
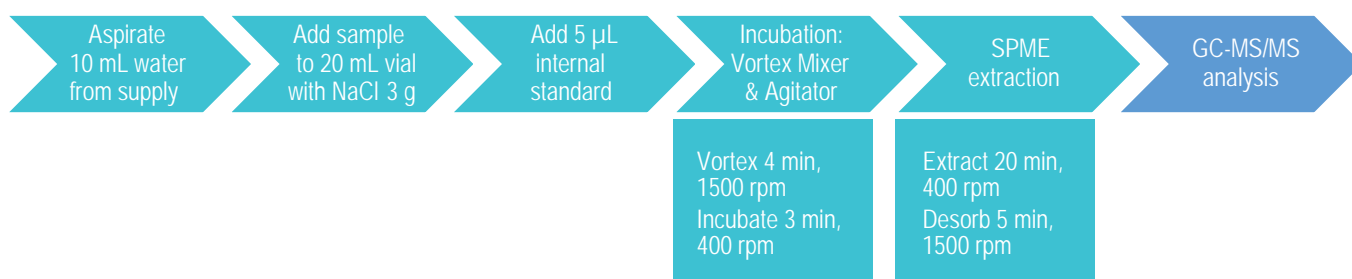

- 1 SPME Conditioning Station
- 2 10 µL Syringe Tool
- 3 10 mL Syringe Tool
- 4 Large Wash Module
- 5 Vial Tray Plate
- 6 Agitator Module
- 7 Vortex Mixer Module
- 8 Real Time Water Tank

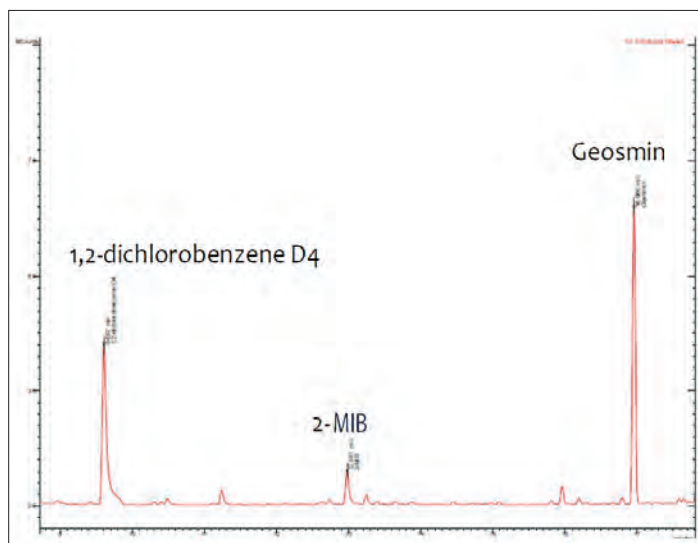

Compound	Geosmin	2-MIB
R ²	0.998	0.995
Spiking conc. (ng/L)	1	2
LOD (ng/L)	0.16	0.17
LOQ (ng/L)	0.51	0.56
Precision (RSD %)	4.5	2.7
Recovery (%)	115	106



PAL Accessories & Consumables
The small parts that make all the difference



To get reproducible results everything is important. Even vial caps can make the difference between a successful batch and an aborted run.

All parts in the PAL Accessories & Consumables range have been extensively evaluated in routine labs:

- GC- and LC-syringes
- Headspace syringes
- Syringe needles
- Pipette tips for Pipette Tool
- ITEX Dynamic Headspace traps
- PAL [SPME Fibers](#)
- PAL [SPME Arrows](#)
- μ SPE cartridges
- Vials
- Vial caps
- Spare parts



Detailed information and specifications are listed in our [Accessories and Consumables brochure](#).



Dimensions

	compact x-axis length	standard x-axis length	xtended x-axis length	xpanded x-axis length
Working Space	Width: 420 mm (16.8 inches) Depth: 255 mm (10.0 inches) Height: 420 mm (16.8 inches)	Width: 735 mm (28.9 inches) Depth: 255 mm (10.0 inches) Height: 420 mm (16.8 inches)	Width: 1090 mm (43.0 inches) Depth: 255 mm (10.0 inches) Height: 420 mm (16.8 inches)	Width: 1511 mm (60.4 inches) Depth: 255 mm (10.0 inches) Height: 420 mm (16.8 inches)
Footprint Instrument dimensions with standard legs	Width: 600 mm (24.0 inches) Depth: 795 mm (31.8 inches) Height: 770 mm (30.8 inches)	Width: 915 mm (36.6 inches) Depth: 795 mm (31.8 inches) Height: 770 mm (30.8 inches)	Width: 1270 mm (50.8 inches) Depth: 795 mm (31.8 inches) Height: 770 mm (30.8 inches)	Width: 1768 mm (70.7 inches) Depth: 795 mm (31.8 inches) Height: 770 mm (30.8 inches)

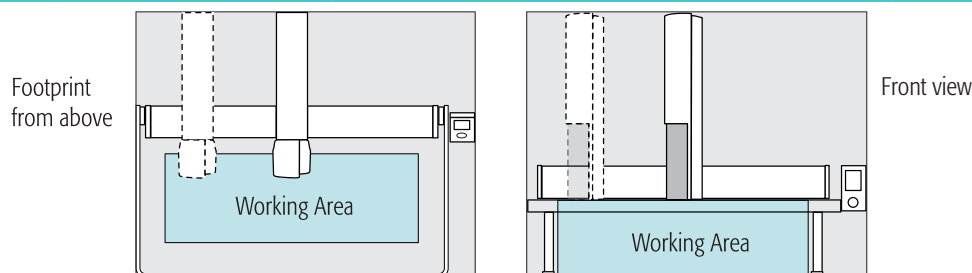

Sample Capacity	2 Tray Holders Up to 420 1 mL vials 324 2 mL vials 90 10/20 mL vials 6 MT/DW plates	4 Tray Holders Up to 840 1 mL vials 648 2 mL vials 180 10/20 mL vials 12 MT/DW plates	6 Tray Holders Up to 1260 1 mL vials 972 2 mL vials 270 10/20 mL vials 18 MT/DW plates	9 Tray Holders Up to 1890 1 mL vials 1458 2 mL vials 405 10/20 mL vials 27 MT/DW plates
Sample Capacity Temperature Controlled (4-40°C)	1 Peltier Stack With 6DW up to: 420 1 mL vials 324 2 mL vials 90 10 mL vials 6 MT/DW plates	Max. 3 Peltier Stacks With 6DW up to: 1260 1 mL vials 972 2 mL vials 270 10 mL vials 18 MT/DW plates	Max. 4 Peltier Stacks With 6DW up to: 1680 1 mL vials 1296 2 mL vials 360 10 mL vials 24 MT/DW plates 9216 samples (with 384 well MTPs)	Max. 6 Peltier Stacks With 6DW up to: 2520 1 mL vials 1944 2 mL vials 540 10 mL vials 36 MT/DW plates 13824 samples (with 384 well MTPs) Max. 27648 samples with 6 x Peltier Stack 12MT und 384 MTPs.

Supported injection techniques

Tool	Ranges/Tools
Liquid Injection Tools	1.2 - 100 µL syringes, 57 and 85 mm needle lengths 250 - 1000 µL syringes, 57 and 85 mm needle lengths 5 & 10 mL syringes
Headspace Extraction	1 mL / 2.5 mL / 5 mL, with corresponding tools
Solid Phase Micro Extraction (SPME & SPME Arrow)	SPME tool (holds commercially available fibers), SPME Arrow tool
Multiple Headspace Extraction (MHE)	MHE tool for 10 and 20 mL vials
ITEX Dynamic Headspace Extraction	ITEX DHS tool with Tenax TA adsorbent (other materials upon request)
Pipette Tool Injection	Direct injection from pipette tip into LC-valve

Available Modules

Agitator Module	Temperature controlled agitation, 40-200°C, 250-750 rpm
Barcode Reader Module	Reads 1D barcodes on 2, 10, 20 mL vials
DeCapper Module	Opens & closes 2, 10 & 20 mL screw cap vials
Dilutor Module	Fast and accurate dispensing of larger volumes of up to 5 different liquids
Fast Wash Module	Efficient cleaning of syringes / needles (gauge 19-26) with 2 different solvents
Flow Cell	Up to 6 flow cells for online sampling
Large Wash Module	2 x 100 mL solvent container and waste port for cleaning of syringes / needles
Liquid Cooler	Trayholder & tray for 32 10/20 mL vials (external cooler not included)
Multiple Headspace Extraction Module	Tool & holder for MHE
Peltier Stack Modules (2DW, 6DW, 12MT)	Temperature controlled storage 4-40°C for a range vials and multiterplates
Solvent Module	3 x 100 mL solvent container for the addition of larger volumes of liquids
SPME Fiber Conditioning Module	Conditioning of SPME fibers, up to 350°C, optional purge gas connection
Standard Wash Module	4 x 10 mL solvent vial, 1 x 10 mL waste vial
Valve Drive Module	For Rheodyne or Valco injection & switching valves
Vortex Mixer Module	Efficient mixing for 2, 10, 20 mL vials

LC Application Specifications

Type	Specifications	Comment
Injection volume	0.1-10000 µL	Depending on syringe
Liquid injection, repeatability (gravimetric)	Full loop < 0.1 % RSD Partial loop < 0.15 % RSD	20 µL loop, 4 x overflow 10 µL in 20 µL loop
Liquid injection, linearity (gravimetric)	R > 0.9999	20, 40, 60, 80, 100 µL, n=3 each level
Liquid injection from small sample volume	3 injections 1 µL out of 5 µL	With bottom sense option and conical 150 µL vial
Carryover	< 30 ppm	With LC/MS Tool, blank measured after injection of Cl-Hexidine 0.6 mg/mL

GC Application Specifications

Type	Specifications	Comment
Injection volume	0.1-10000 µL	Depending on Syringe
GC liquid injection, repeatability	< 0.60 % RSD	Alkanes C14, C15, C16, 1 µL, split mode
GC liquid injection, linearity (gravimetric)	R > 0.9999	20, 40, 60, 80, 100 µL, n=3 each level
GC head space injection, repeatability	< 1.00 % RSD	Iso-octan, 10 µL in 20 mL vial, 500 µL injection
GC needle discrimination	C40/C20 > 0.98	Restek Florida Mix 1 µL, 100 ms fast split/splitless injection

Detailed specifications on request.

PAL SYSTEM

Ingenious sample handling



Contact the experts for sample preparation:

Or find your nearest [value added reseller](#).



For more information on the PAL RTC and RSI, including the latest application notes visit:

www.palsystem.com



PAL is a registered trademark of CTC Analytics AG, Switzerland